

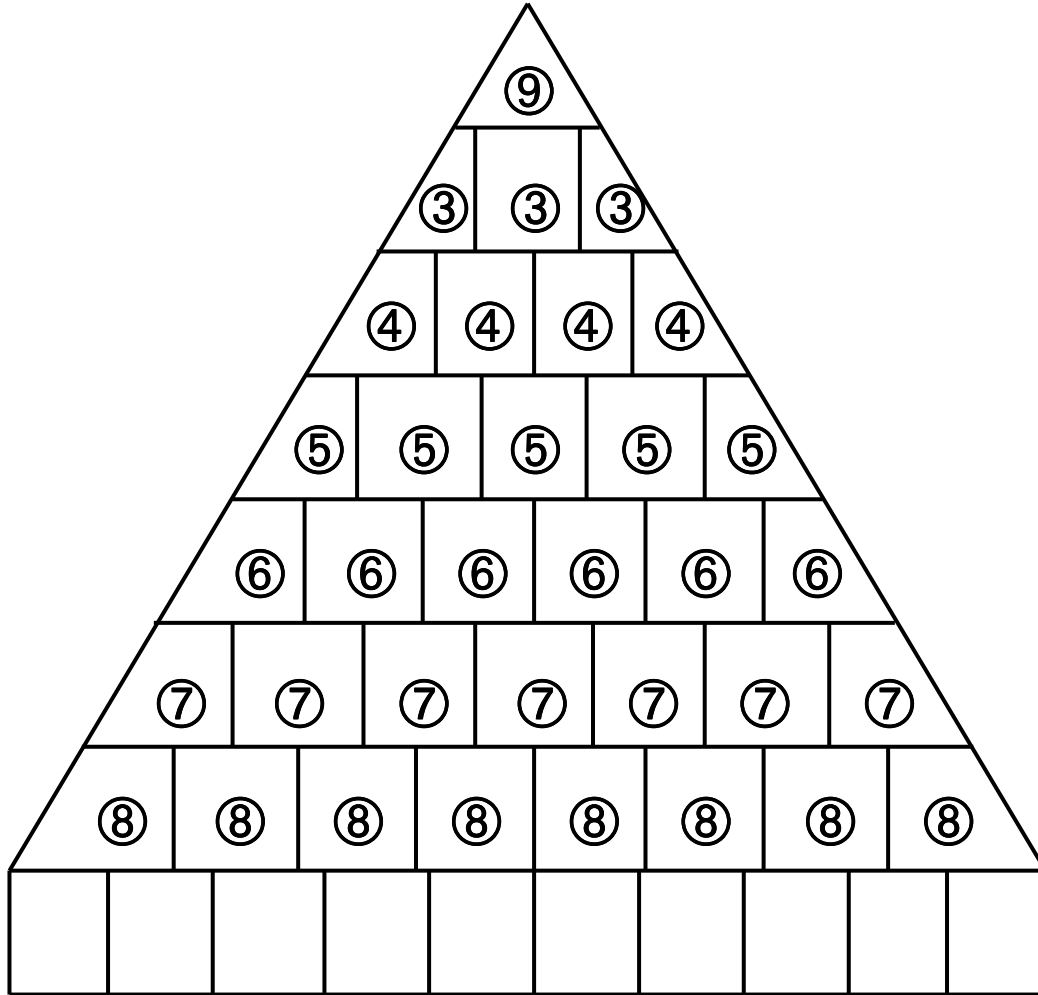

Pyramidespil

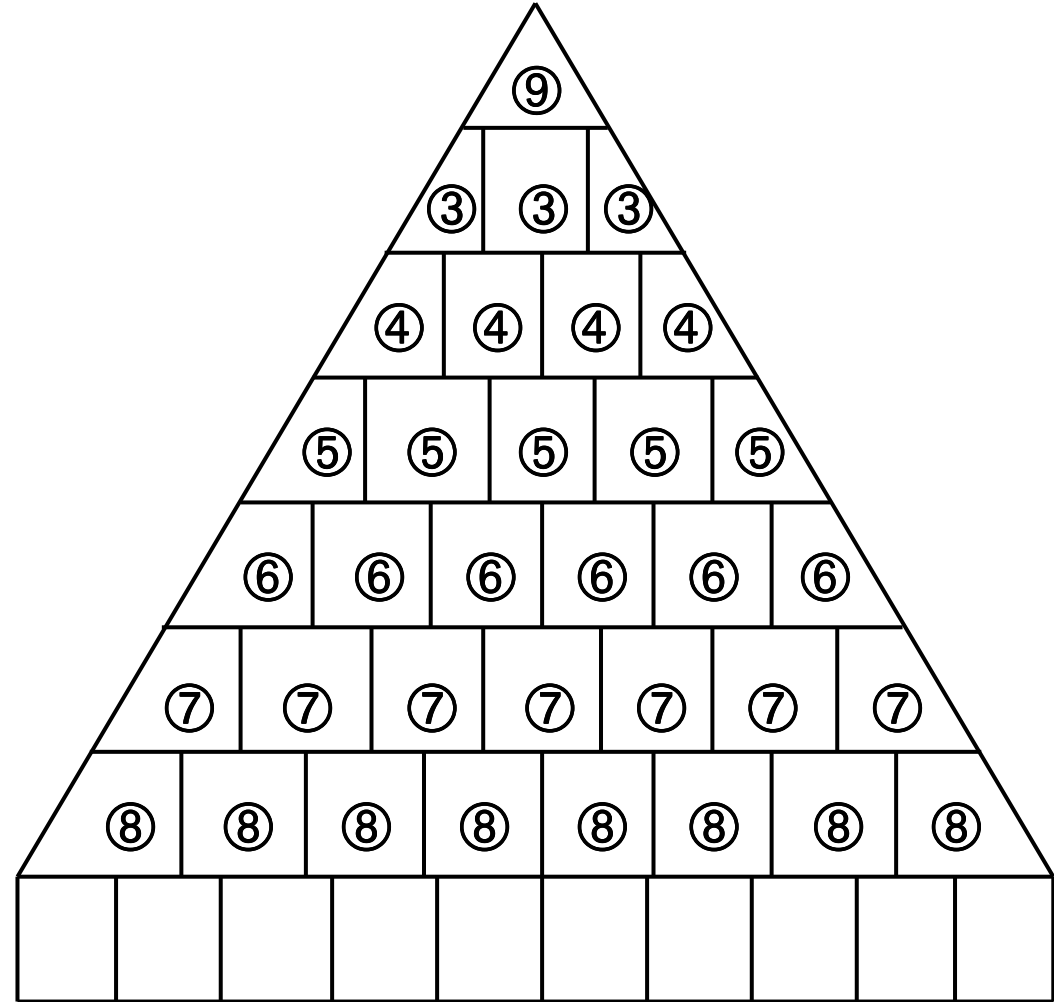

Pyramidespil





Parløb

	NAVNE	P	O	P	O	P	O	P	O	P	O	P	O	P	O	P	O	P	O	P	O	P	O
1																							
2																							
3																							
4																							
5																							
6																							
7																							
8																							
9																							
10																							

14=1 omgang
 15= 2 omgange
 O.s.v.

HUSNUMMER

1. omgang

2. omgang

DANSK KEGLE FORBUND©
HUSNUMMER

Navn	1	2	3	4	5

Navn	1	2	3	4	5

Efter første slag, skal du placere et tal i et felt, osv.....





Hvem går sidst ned med flaget?

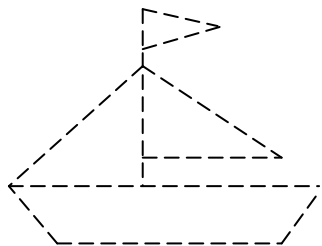

Navn

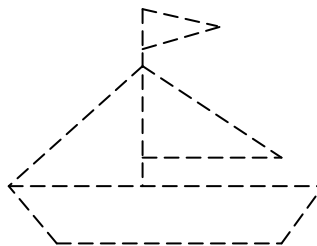

Navn

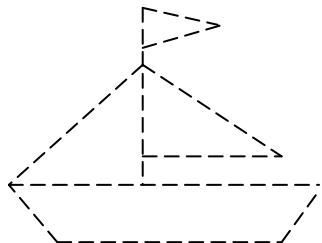

Navn

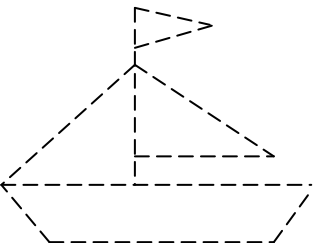

Navn

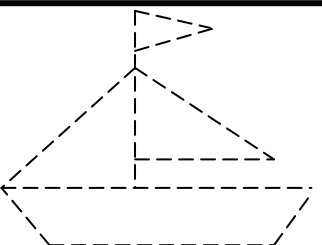

Navn

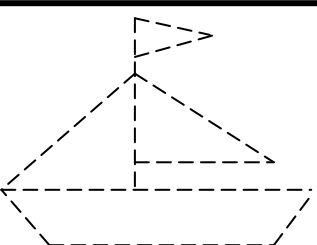

Navn

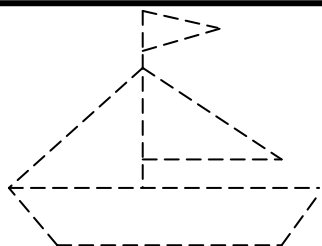

Navn

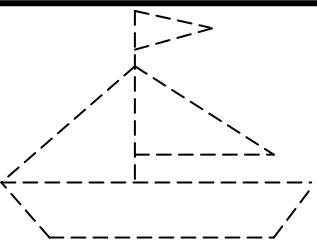

Navn

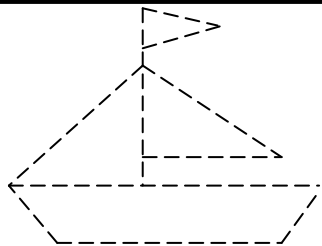

Navn

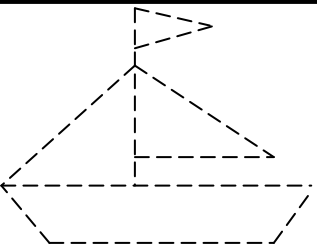

Navn

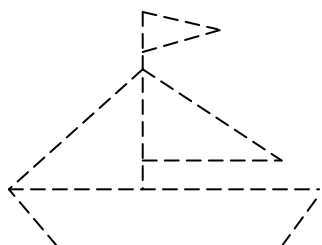

Navn

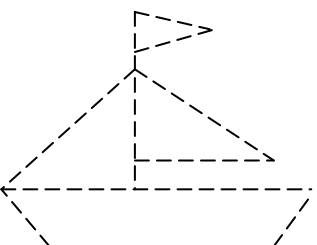

Navn

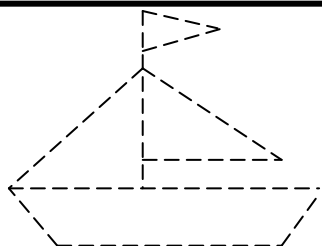

Navn

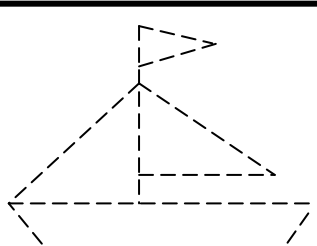

Navn

Kongespil

Dato:

	60															
	60															
	60															
	60															
	60															
	60															
	60															
	60															
	60															
	60															
	60															
	60															
	60															
	60															
	60															
	60															
	60															
	60															
	60															
	60															

9 = 12, 8 = 10, 8 om bagkegle = 10, 8 = 9, 7 = 8, 6 = 7, 5 = 6, 4 = 4, 3 = 3, 2 = 2, 1 = 1, 0 = +1

Pokerspil



NAVN	1.	2.	3.	4.	5.	Bemærkning

Rækkefølge:

2 ens efter hinanden

2 par efter hinanden

3 ens efter hinanden

4 i rækkefølge (Royal eks.: 5-6-7-8)

3 + 2 ens (Fuldt hus)

4 ens efter hinanden (Poker)

5 i rækkefølge (Royal Flush)

Derudover er 9'eren højest og f.eks. 4-5-6-7 slår 3-4-5-6



De 4 regningsarter

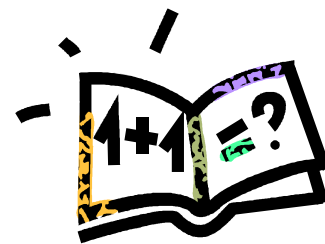

Navn	A + B = C	C x D = E	E x F = G	G / H = I	I

DANSK KEGLE FORBUND©
DE 4 REGARTER



Eksempel – de markerede felter er slagene:

A	B	C	D	E	F	G	H	I
6	8	14	7	98	8	784	3	261

Labyrint

DANSK KEGLE FORBUND©
LABYRINT

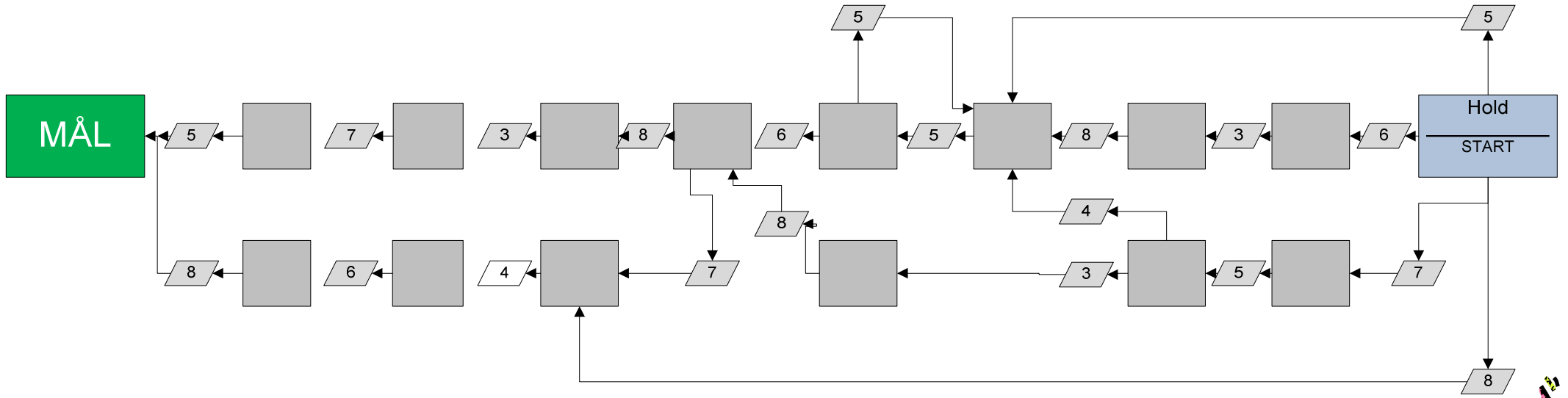

Labyrint

DANSK KEGLE FORBUND©
LABYRINT

